



TWIN F IV 3.5

THE SPACE-SAVING SOLUTION

made by MAHA



HIGH CONVENIENCE OF OPERATION

WITH SPACE-SAVING DESIGN

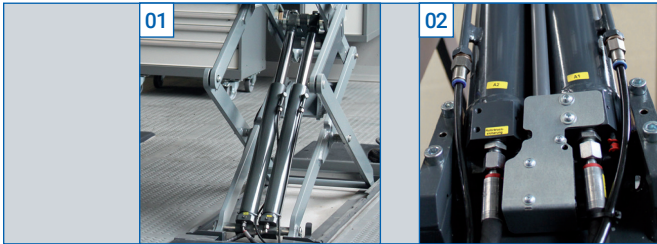

01 Double safety provision with two lifting cylinders on each scissors side, fully hydraulic system, no safety latch and no air pressure needed for operation.

02 The stroke travel of both cylinder pairs on each scissor side is measured via cable pull potentiometer, the hydraulic synchronization is conducted automatically by the control. The operator is freed from manual leveling compensation.



03 All bearings are maintenancefree due to self-lubricating Teflon bearing bushes.

04 High lateral stability due to heavily dimensioned scissor arms.



05 Flush-floor routing of hydraulic hoses and cables possible, no tripping obstacles for persons!

06 Maintenance-free cylinder raising support: full lifting capacity is effective at lower heights already. Smooth pick-up and lowering of load with reduced speed.

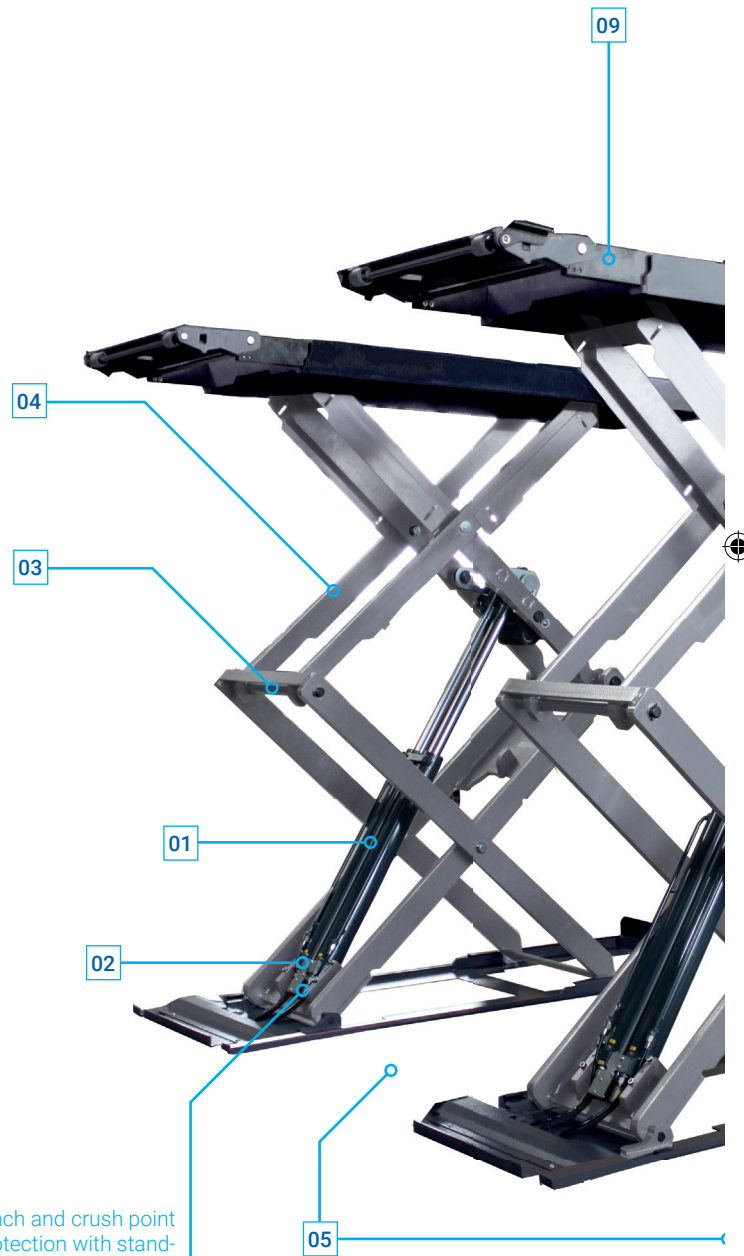

Pinch and crush point protection with standard delivery CE Stop (audible warning signal).

The workshop floor requirements regarding attachment and installation are low. In general, installation is quick and easy. If the lift needs to be moved to another location, disassembly and re-assembly is problem-free. The TWIN F series is then ideally suited for leased real estate.

The standard delivery granulate coating of lifting plates and extensions enables slip-free drive-over with the vehicle even when wet, and slip-free lifting of the vehicle with support blocks.

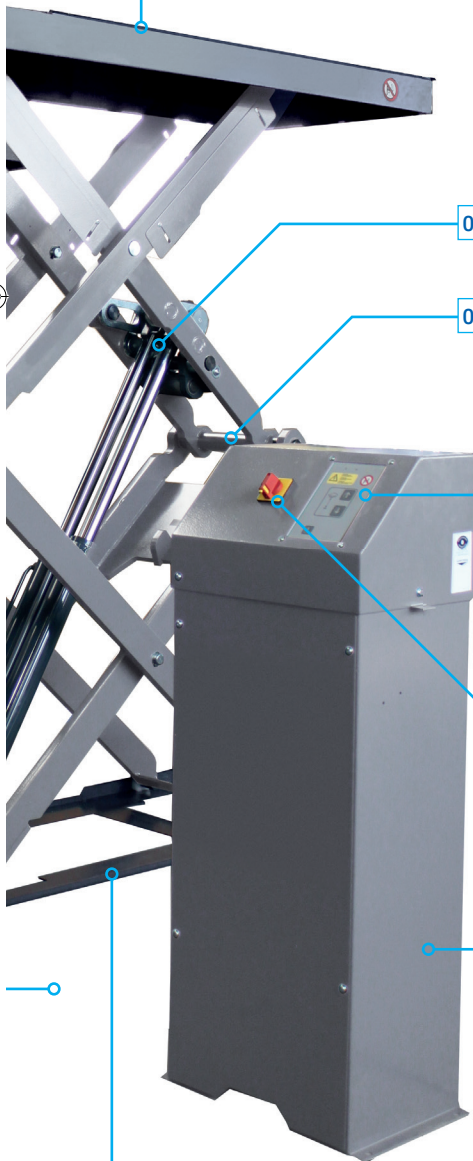

06

03

07

Manual lowering function in the event of power failure outside the danger zone at operations desk.

08

The operations desk can be positioned either left or right of the lift (standard delivery is right).

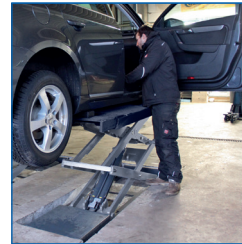

07



The vehicle doors of the lifted vehicle can be completely opened. The free side access to the vehicle offers comfortable working conditions.

Robust foil keypad for operation.

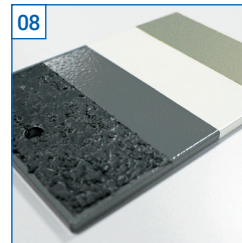

08

High corrosion protection of floor frame with standard delivery 2-layer powder coating.

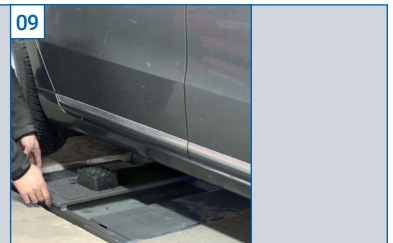

09

Continuously extendable support plates offer high user comfort – no vehicle pushing for adjustment needed.



Very long extension length of the support plates (1550 – 2100 mm), making lifting of smaller vans possible.

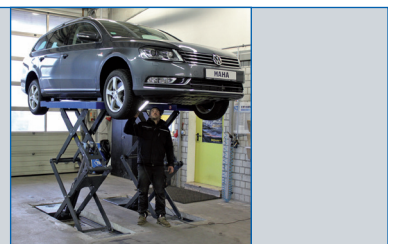

The generous lifting height allows comfortable working even with flush-floor installation.

TWIN F IV 3.5 U

(flush-floor installation)

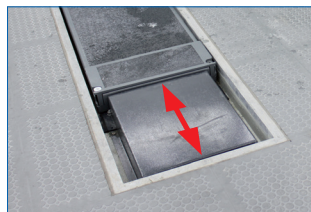

Due to foundation compensation boxes (which come standard), both extensions of the flush-floor installed twin scissors lift can be length adjusted even when the lift is fully retracted. Also, the lift can be fully lowered without having to push in the extensions (TWIN F IV 3.5 U).

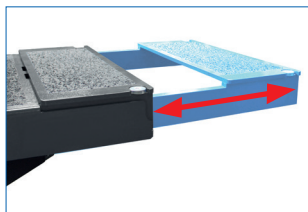

Support plates can be continuously extended from 1550 mm to 2100 mm.

TWIN F IV 3.5 A

(above-floor installation)

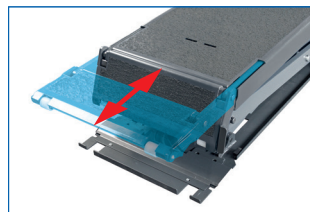

Flap down and fully retracted for minimum length (1550 mm), snapped into place at the top and continuously extended for maximum length (2100 mm).



With a drive-on height of no more than 105 mm, the hinged extensions also serve as access ramps.

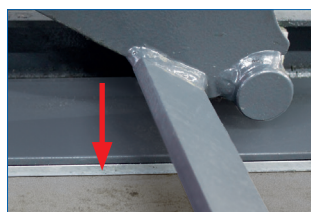

Hot-dip galvanised shim plate (comes standard) protects the floor frame from direct contact with dirty water, adding corrosion protection.



Ideal for manoeuvring in narrow approach areas: can be driven over in crosswise direction.

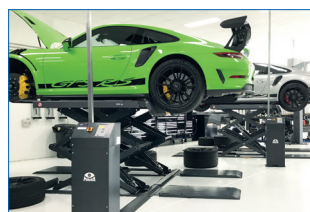

The optionally available drive-over ramps for lowered vehicles ...



... reduce the drive-over height to 65 mm, which allows easy access to the lift even for vehicles with very low ground clearance.

OPTIONS



Various support blocks (4 pieces) (in mm):
Rubber pad, flat 150x100x20
Hard rubber block 120x100x50
Ductile synthetic block 340x132x47 or 340x132x95



The drive-over height of the surface mounted lift is reduced by 40 mm with the optionally available drive-over ramps. (TWIN F IV 3.5 A).



The lift can be moved using a conventional dolly or forklift thanks to the optional mobile frames. The lift requires no anchoring to the floor, the installation frame is self-supporting and only requires a solid ground surface. The drive-over height of the lift is increased by only 12 mm (TWIN F IV 3.5 A).



MAHA Maschinenbau Haldenwang GmbH & Co. KG
Hoyen 20
87490 Haldenwang
Germany

maha.de